







Fitting for 2–10 folding sliding shutters made of wood or metal up to 30 kg (66 lbs.) per shutter and 180 kg (397 lbs.) per system, with concealed running and guide tracks. Design Forslide, open at the top.

**Product highlights**

- 
**Aesthetics** Harmonious combination of shutters and façade, since the running and guide tracks disappear behind the closed shutter
- 
**Flexibility** Solution for any construction situation with doors of up to 1.2 m<sup>2</sup> (13 ft<sup>2</sup>) and 30 kg (66 lbs.), even/odd number of doors and system width of up to 12 m (39' 4 7/16")

**Technical specifications**

-  Max. 30 kg (66 lbs.)
-  Max. 3200 mm (10'5 31/32")
-  Max. 600 mm (1'11 5/8")
-  28–36 mm (1 3/32"–1 13/32")

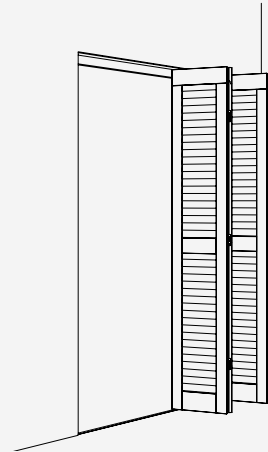

**Installation examples**

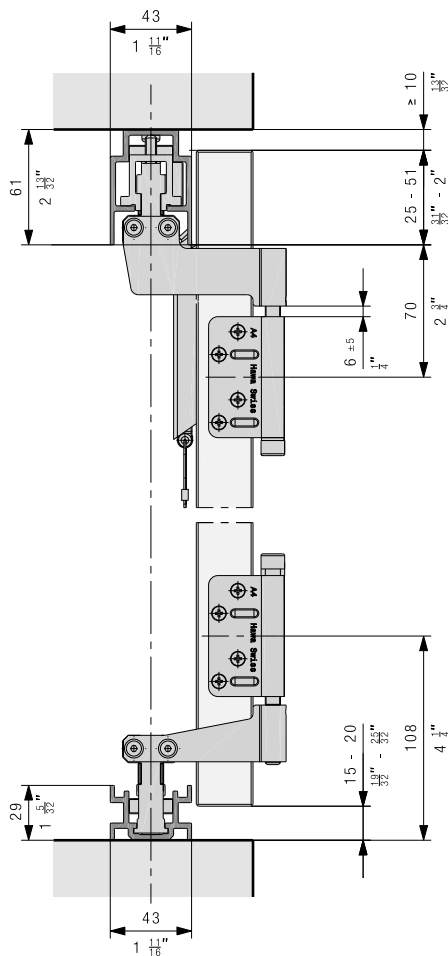

**Set for folding packages**

		No.
	Hawa Frontfold 30 FS, basic set right, guide track open at the top	27558
	Hawa Frontfold 30 FS, basic set left, guide track open at the top	27559
	Hawa Frontfold 30 FS, additional set, guide track open at the top	27560

<b>Set consisting of:</b>		27558	27559	27560	No.
	Fixed suspension, Forslide, folding to the right	1			27517
	Running gear outside, Forslide, folding to the right	1			27519
	Fixed guide, Forslide, folding to the right, guide track open at the top	1			27533
	Outside guide, Forslide, folding to the right, guide track open at the top	1			27534
	Cylinder screw, M8x100 mm, A4-70	4	4	2	27401
	Hinge ring, plastic	2	2	1	15740
	Hinge plate cranked, one-piece, stainless steel A4	4	4		27418
	Fixed suspension, Forslide, folding to the left		1		27518
	Running gear outside, Forslide, folding to the left		1		27520
	Fixed guide, Forslide, folding to the left, guide track open at the top		1		27532
	Outside guide, Forslide, folding to the left, guide track open at the top		1		27535
	Centre running gear, Forslide			1	27521
	Centre guide, Forslide, guide track open at the top			1	27537
	Hinge plate cranked, two pieces, stainless steel A4			4	27419

**Set for uneven number of leaves**

	No.
Hawa Frontfold 30 FS oo, set for uneven number of leaves left	30168
Hawa Frontfold 30 FS oo, set for uneven number of leaves right	30169



**Set consisting of:**

		30168	30169	No.
	Fixed suspension, Forslide, folding to the left	1		27518
	Fixed guide, Forslide, folding to the left, guide track open at the top	1		27532
	Hinge plate cranked, one-piece, stainless steel A4	2	2	27418
	Cylinder screw, M8x100 mm, A4-70	2	2	27401
	Hinge ring, plastic	1	1	15740
	Fixed suspension, Forslide, folding to the right		1	27517
	Fixed guide, Forslide, folding to the right, guide track open at the top		1	27533

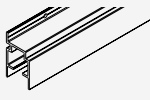
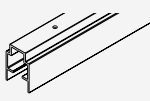



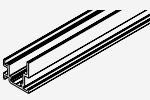
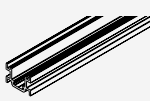





**Running tracks**

		mm (inch)	No.
	Running track, Forslide, wall mounting, aluminum, anodized	6000 (19'8 7/32")	27358
		cut to size	27622
	Running track, Forslide, ceiling mounting, aluminum, anodized	6000 (19'8 7/32")	27360
		cut to size	27623

**Guide tracks**

		mm (inch)	No.
	Guide track, wall mounting, aluminum, anodized	6000 (19'8 7/32")	27364
		cut to size	27625
	Guide track, floor mounting, aluminum, anodized	6000 (19'8 7/32")	27366
		cut to size	27626
	Guide track, narrow, aluminum, anodized	6000 (19'8 7/32")	27368
		cut to size	27627

**Accessories**

		No.
	Tension latch, opening outwards, with steel cable, without fixing screws	27490
	Tension latch, opening inwards, with steel cable, without fixing screws	27491
	Rotary handle for tension latch, stainless steel	27458
	Flat hinge, gap size 1–6 mm (1/32" to 1/4"), stainless steel A4	27421
	Cranked hinge, gap size 6 mm, stainless steel A4	27595
	Hinge plate cranked, two pieces, stainless steel A4	27419
	Hinge plate flat, two pieces, stainless steel A4	27420
	Hinge pin A4	20187
	Drilling jig for hinge, Ø 3mm for screw fixing, including threaded bolt	27551
	Drilling jig for hinge, Ø 5mm for riveting, including threaded bolt	27552
	Stop with adjusting screw, suitable for profile bar 8 mm from the espagnolette locking device	15899

**Running track wall installation**

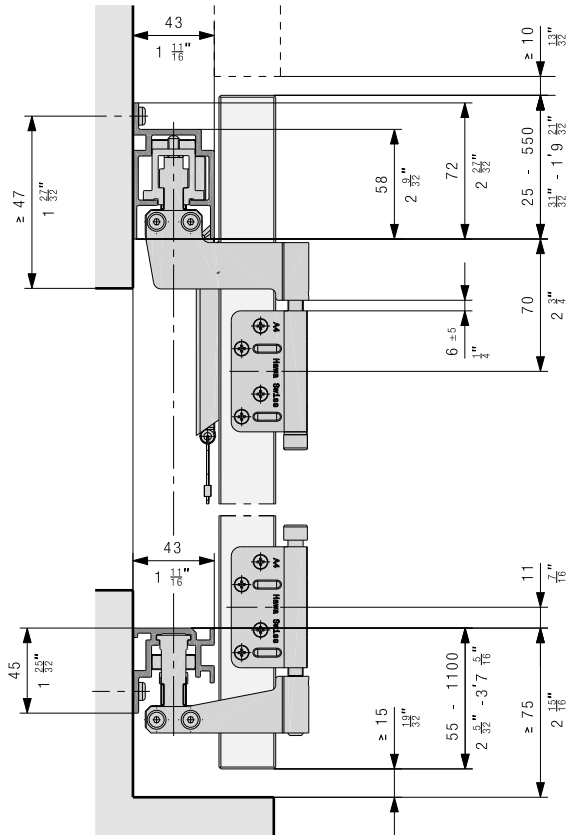

**Guide track wall installation**

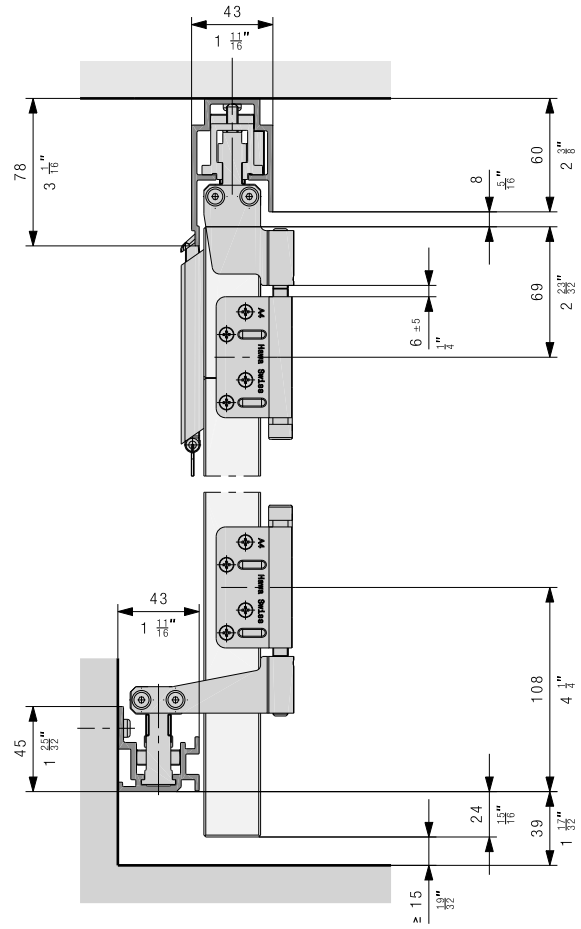

**Guide track embedded in the floor**

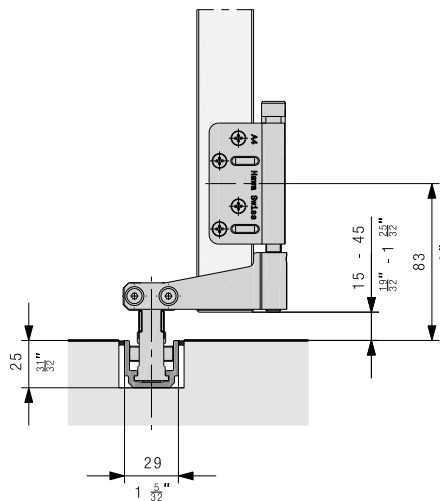

**Planning folding package**

Customer installation of a wind support is recommended.

With an odd number of doors, the last door must be secured by the customer.

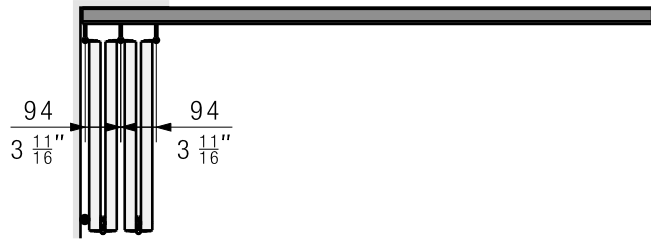

**Running gear and guide hinge**

With folding sliding shutters more than 33 mm (1 5/16") thick, the hinges must be embedded.

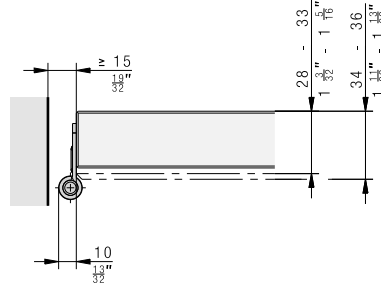

**Options folding hinges**

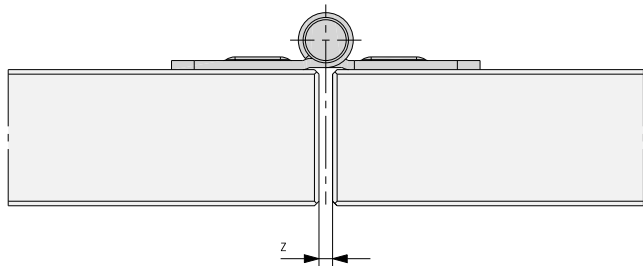

Variant 1, flat hinge: Z = 1–6 mm (1/32" to 1/4")

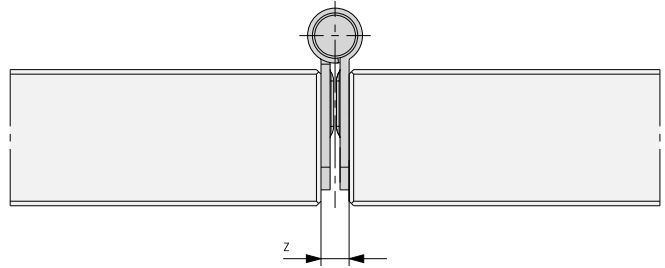

Variant 2, cranked hinge: Z = 6 mm (1/4")

**Gap sizes**

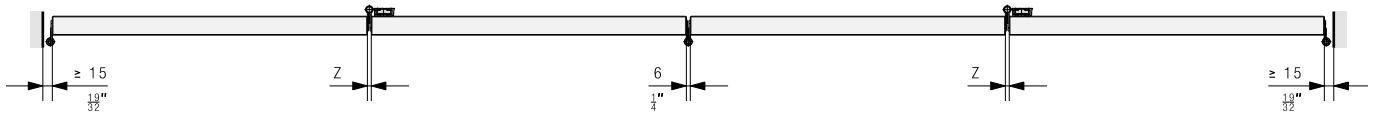

**Number of hinges**

Height	Quantity
up to 2000 mm	2
from 2001 mm	3

**Ordering information**

- Type and number of sets
- Type and number of hinges
- Type and number of tension latches and rotary handles
- Type and number of running tracks
- Type and number of guide tracks

**Optional ordering information**

- Type and number of drilling jigs
- Order overview from page 194

**Planning/execution**

Further information about the product can be found on [www.hawa.com](http://www.hawa.com).